

INDUSTRIAL ROTATOR CPR5

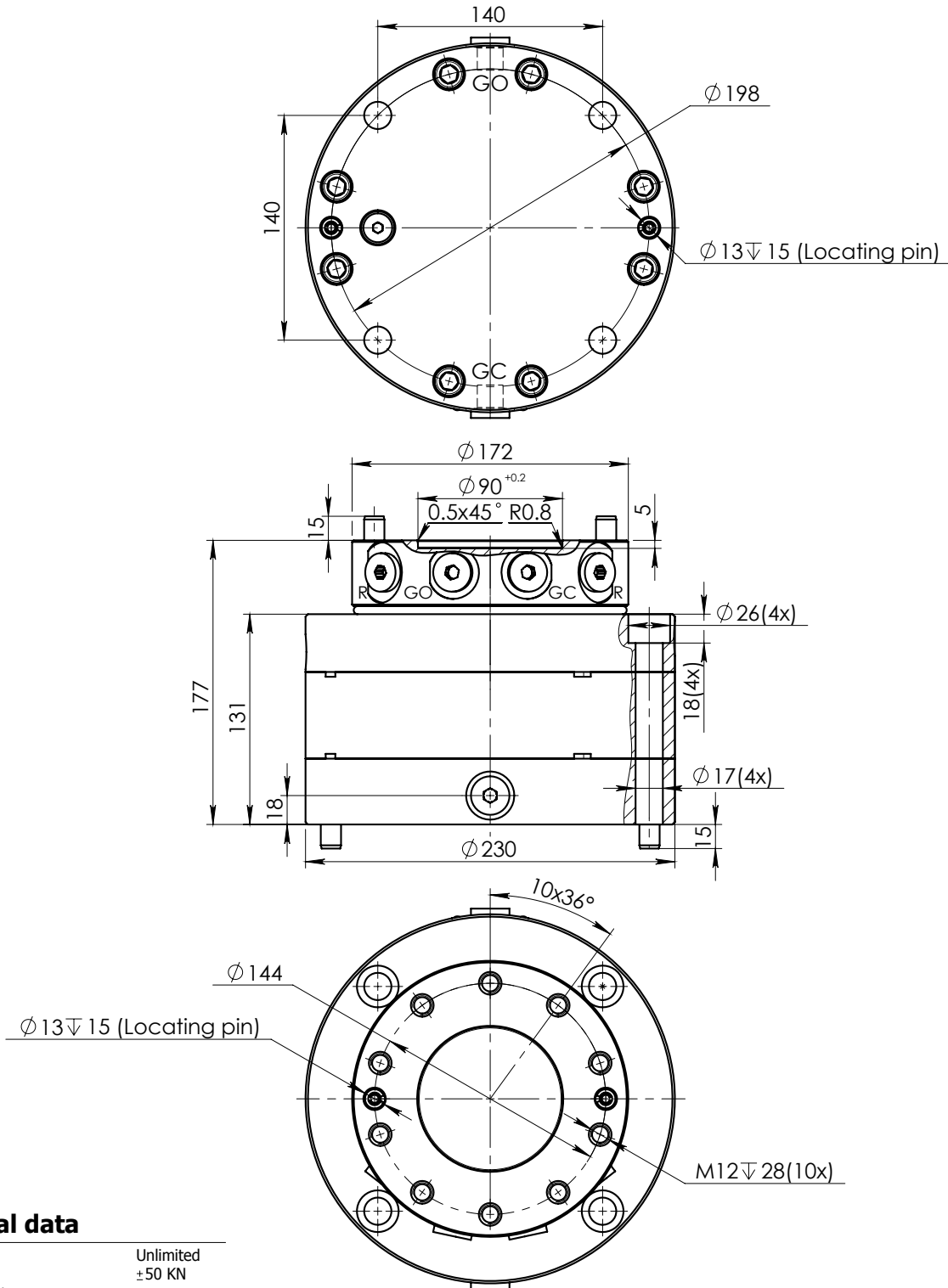

Technical data

Rotation	Unlimited
Max axial load	±50 KN
Max radial load	36 KN
Torque at 25 Mpa	1350 Nm
Rated displacement	354 cm ³ /rev.
Rotation speed	max 30 rpm
Oil duct area for grapple	95 mm ²
Weight	45 kg

Function	Max working pressure	Rec oilflow	Connection
R - rotation	25 MPa*	15 l/min	M 18x1.5
GO - grapple/tool open	35 MPa		M 18x1.5
GC - grapple/tool close	35 MPa		M 18x1.5

* Relief valves fitted

Sheet 1 of 3

17.01.2017